

Track System Specification

MT20CD

— MagTrack 20 series



◎ Basic Parameters

- Material: AL6063-T5,spraying surface
- Coating: Black (RAL9005)/White (RAL9003)
- Length: 600mm,900mm,1200mm optional
- IP grade: IP20
- CCT: 2700K,3000K,4000K
3000K-4000K-5000K optional
- CRI: 90
- SDCM: <3 Step (ANSI)
- Light efficiency: 100 LM/W
- Input voltage: DC24-48V, DC48V
- Lighting direction: Downward
- Dimming method: Non-dimming,DALI-2,Tuya Bluetooth,CASAMBI
- Application: Indoor
- Certification: CE,UKCA,ROHS,Reach
- Warranty: 5 years

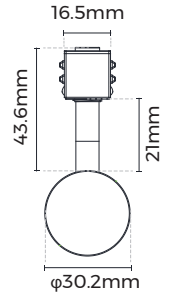
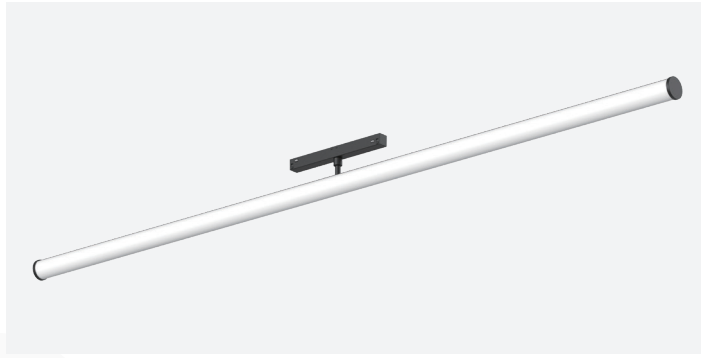

◎ Product mechanical data

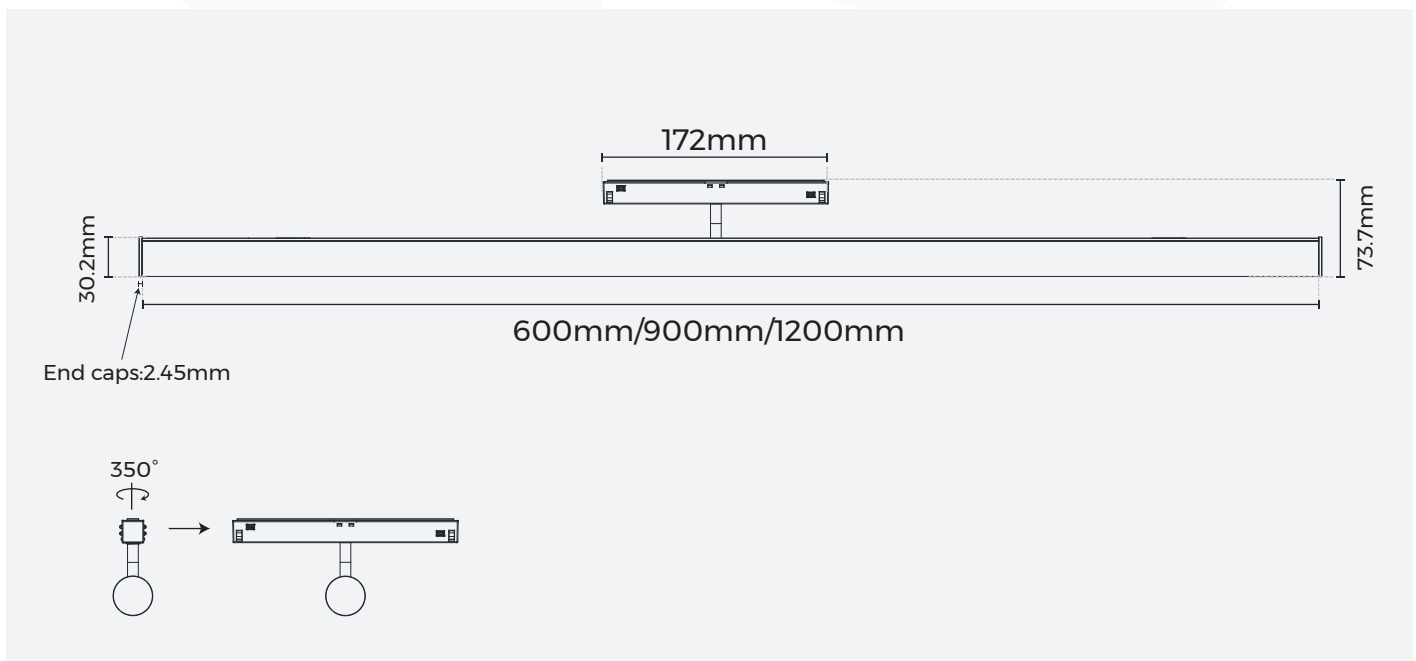

© Luminaire Parameters

Version	Model	Length	Input Voltage (V)	Max. Current (A)	Type Power (W)	Max. Power (W)	CRI	Beam Angle	Lumen @4000k (LM)
Normal	MT20CD	600mm [1.97ft]	24-48VDC	0.50-0.25	12.0 [6.09W/ft]	13.2 [6.70W/ft]	>90	200°x110°	1200 [610LM/ft]
		900mm [2.95ft]	24-48VDC	0.75-0.375	18.0 [6.10W/ft]	19.8 [6.71W/ft]			1800 [610LM/ft]
		1200mm [3.94ft]	48VDC	0.50	24.0 [6.09W/ft]	26.4 [6.70W/ft]			2400 [610LM/ft]
3 CCT tunable (Dial switch)	MT20CD	600mm [1.97ft]	24-48VDC	0.50-0.25	12.0 [6.09W/ft]	13.2 [6.70W/ft]	>90	200°x110°	1080 [548LM/ft]
		900mm [2.95ft]	24-48VDC	0.75-0.375	18.0 [6.10W/ft]	19.8 [6.71W/ft]			1620 [548LM/ft]
		1200mm [3.94ft]	48VDC	0.50	24.0 [6.09W/ft]	26.4 [6.70W/ft]			2160 [548LM/ft]

Note:

1. Test Basis: Output data are based on tests for Ra 90, 4000K luminaires.

- Normal Versions:

- 2700K: Light efficiency & luminous flux = 4000K value × 0.85
- 3000K: Light efficiency & luminous flux = 4000K value × 0.9

- 3-CCT Tunable (Dial Switch) Versions:

- 3000K: Light efficiency & luminous flux = 4000K value × 0.9
- 5000K: Light efficiency & luminous flux = 4000K value × 0.95
- Special Note: 1200mm/24W models are exclusive to 48V.

2. Tolerance: Output data tolerance is within ±10%.

3. Data Nature: Values are typical (not guaranteed minimum)

© Optical Parameter

- Normal

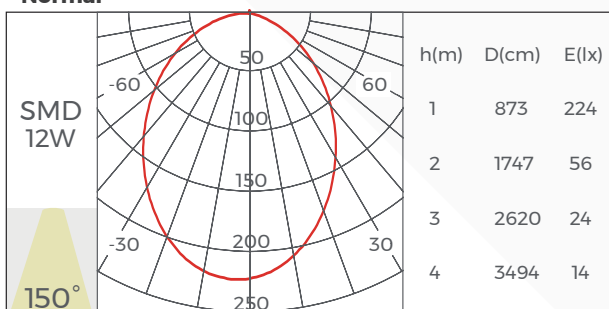

- 3 CCT tunable(Dial switch)

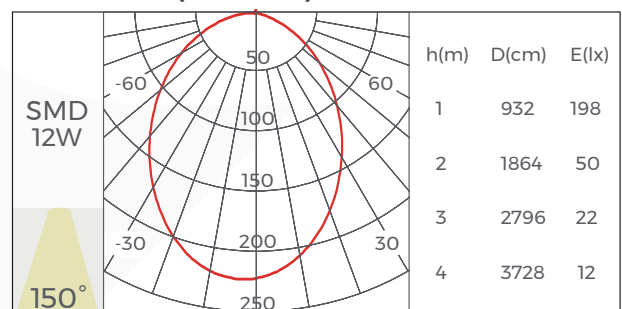

© MagTrack 20 Application

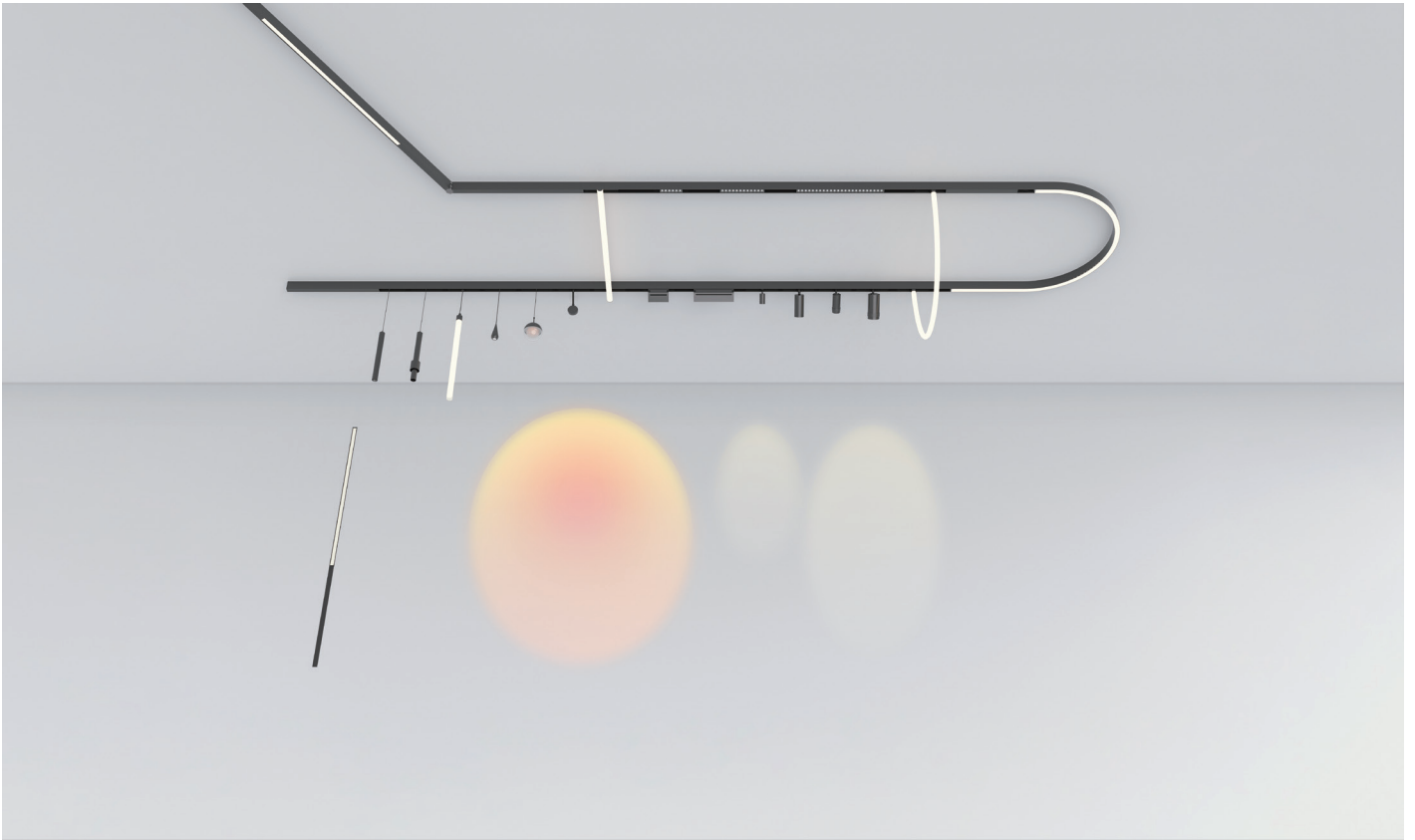

© Points to note

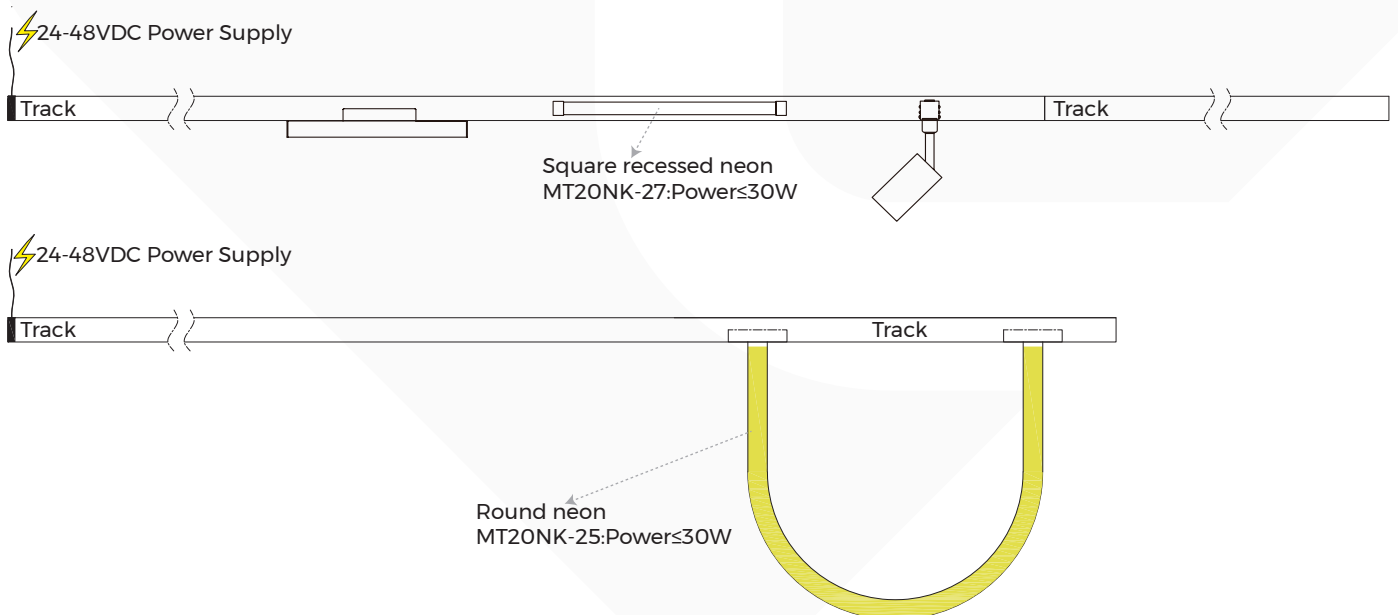



Supplementary power supplies are needed beside the Spotlights module / Decorative module / Linear modular under below one conditions:





1. Power of Square recessed neon MT20NK-27 > 30W
2. Power of Round neon MT20NK-25 > 30W
3. If a DC24V-48V power supply is used to power the track, then only luminaire modules with an input voltage of DC24V-48V can be selected.
4. If a DC48V power supply is used to power the track, then a luminaire module with an input voltage of DC24V-48V or DC48V can be selected.

©MagTrack 20 Product Accessories Information

Picture	Name	Model
	Trimless recessed track (9.5mm gypsum board)	TLS-MR2X0(A)
	Trimless recessed track (12.5mm gypsum board)	TLS-MR2X0(B)
	Trimless recessed track (Ordinary batching)	TLS-MR2X0(C)
	Pendant / Ceiling track	TLS-MS2X0
	Pendant / Ceiling track	TLS-MH2X0
	φ800mm 90° Trimless recessed curve track (9.5mm gypsum board)	TLS-MR208A90(A)
	φ1000mm 90° Trimless recessed curve track (9.5mm gypsum board)	TLS-MR210A90(A)
	φ1200mm 90° Trimless recessed curve track (9.5mm gypsum board)	TLS-MR212A90(A)
	φ800mm 90° Trimless recessed curve track (12.5mm gypsum board)	TLS-MR208A90(B)
	φ1000mm 90° Trimless recessed curve track (12.5mm gypsum board)	TLS-MR210A90(B)
	φ1200mm 90° Trimless recessed curve track (12.5mm gypsum board)	TLS-MR212A90(B)
	φ800mm 90° Ceiling/pendant curve track	TLS-MH208A90
	φ1000mm 90° Ceiling/pendant curve track	TLS-MH210A90
	φ1200mm 90° Ceiling/pendant curve track	TLS-MH212A90

Picture	Name	Model
	Power feeder of track	TLS-M261
	Electrical connector	TLS-M264
	I-shaped electrical connector (Recessed type)	TLS-M265
	I-shaped electrical connector (Surface)	TLS-M266
	End caps	EC-MR20
	End caps	EC-MS20
	End caps	EC-MH20
	Track blind cover	CV-M20FB
	Ceiling accessory	TLS-M271
	Pendant rope set	TLS-M272
	Ceiling screw	CL-01

Picture	Name	Model
	L-shaped corner (Downward)	L90-MR20(A)
	L-shaped corner (Inward)	L90N-MR20(A)
	L-shaped corner (Downward)	L90-MR20(B)
	L-shaped corner (Inward)	L90N-MR20(B)
	L-shaped corner (Downward)	L90-MR20(C)
	L-shaped corner (Inward)	L90N-MR20(C)
	L-shaped corner (Downward)	L90-MS20
	L-shaped corner (Inward)	L90N-MS20
	L-shaped corner (Downward)	L90-MH20
	L-shaped corner (Inward)	L90N-MH20
	L-shaped Adjustable corner (Downward)	L90-MH20(A)
	T-shaped Adjustable corner (Downward)	T90-MH20(A)
	X-shaped Adjustable corner (Downward)	X90-MH20(A)

Picture	Name	Model
	CASAMBI controller	1200EN1812-CAS-XX-BLDAV48
	Magnetic power supply (48V/100W)	MT20-HDRV100H48S-M
	Magnetic power supply (48V/200W)	MT20-HDRV200H48S-M
	48V Constant Voltage Power supply	BN-V48-XXXP

Note:

- 1,Please refer to the accessory list table for detailed parameters.
- 2,Different tracks need to be used with corresponding accessories

©MagTrack 20 Product Economical Accessories Information

Picture	Name	Model
	Trimless recessed track (Ordinary batching)	TLS-ECO-MR2X0
	Trimless recessed track (12.5mm gypsum board)	TLS-ECO-MR2X0(A)
	Pendant / Ceiling track	TLS-ECO-MS2X0
	Pendant / Ceiling track	TLS-ECO-MH2X0
	End caps	EC-ECO-MS20
	End caps	EC-ECO-MH20
	L-shaped corner (Inward)	L90-ECO-MS20
	L-shaped corner (Inward)	L90-ECO-MH20
	Pendant rope set	TLS-ECO-M280
	I-shaped electrical connector (Surface)	TLS-ECO-M281

Note:

1,Please refer to the accessory list table for detailed parameters.

2,Different tracks need to be used with corresponding accessories

NeonTrack Application

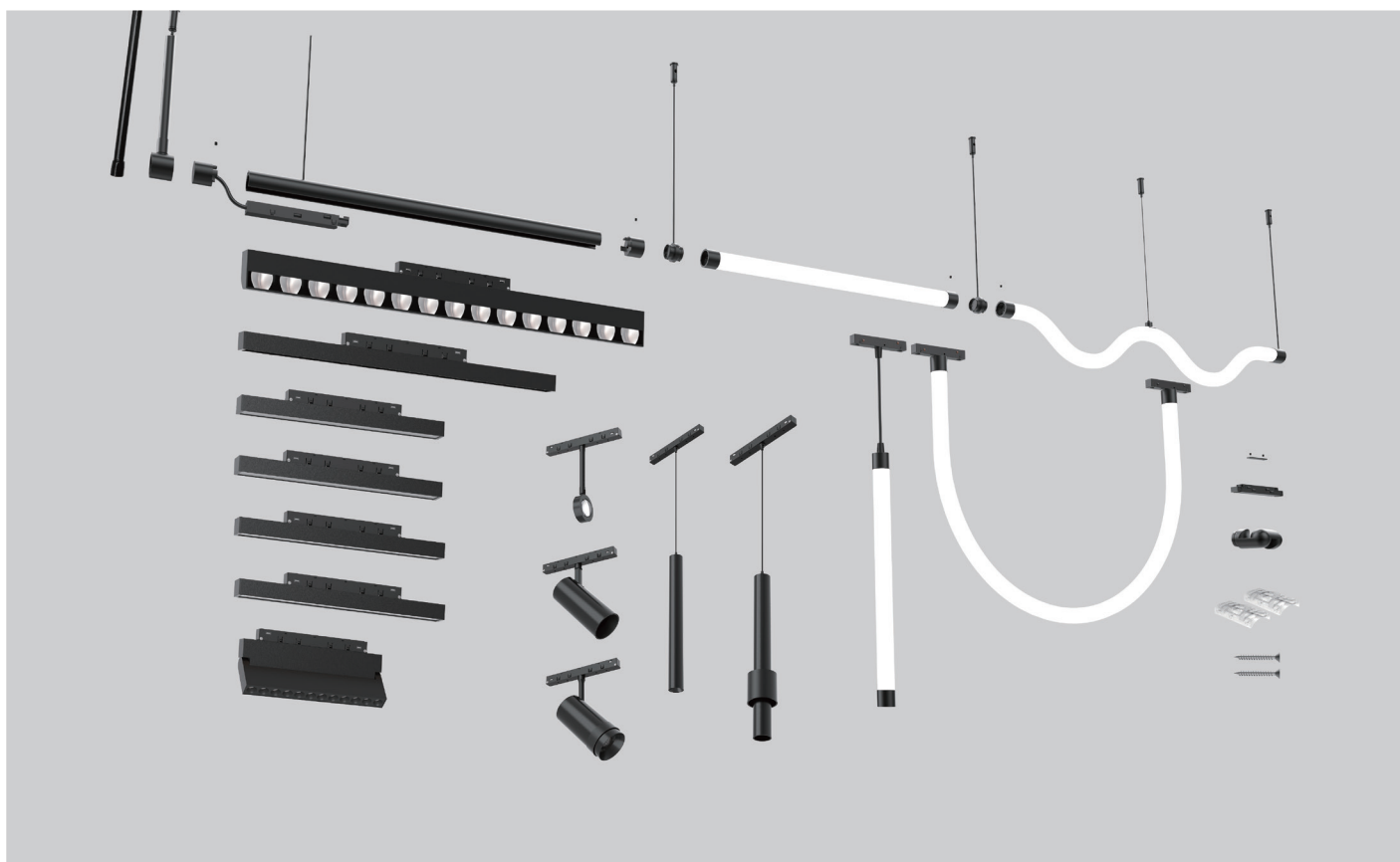



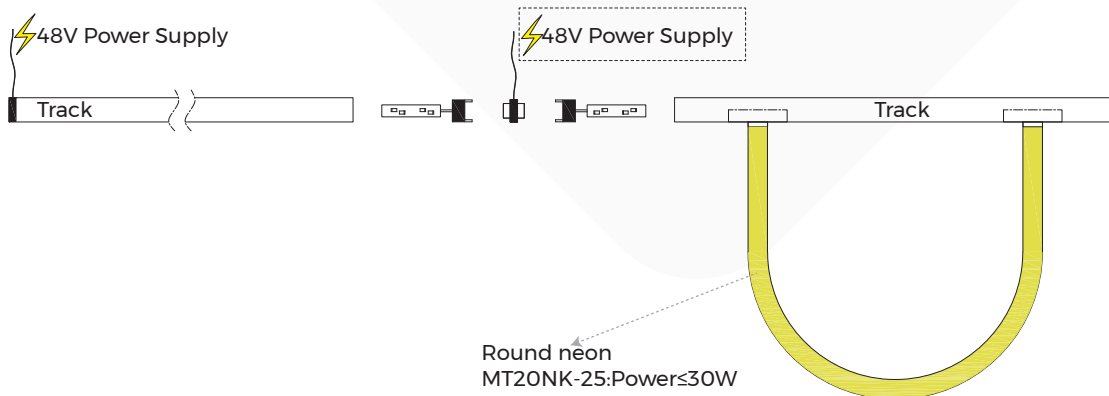
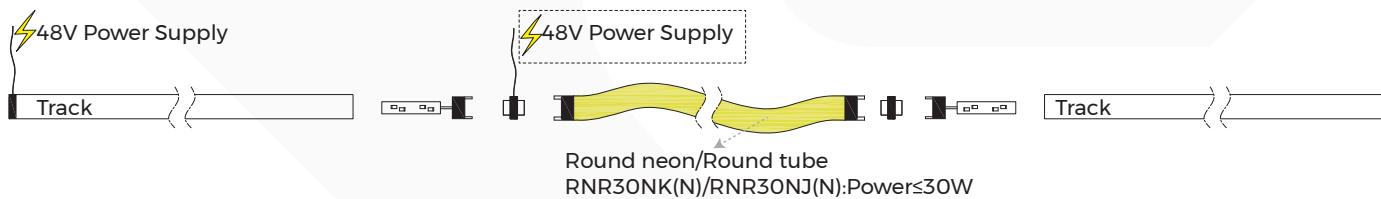
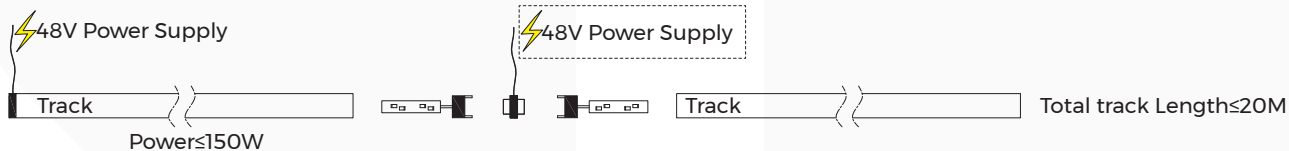

Points to note





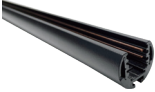

Supplementary power supplies are needed beside the Spotlights module / Decorative module / Linear modular under below one conditions:

1. Load > 150W on the track or Total track length > 20M
2. Power of Round neon/Round tube > 30W

©NeonTrack Product Accessories Information

Picture	Name	Model
	Round track	TLS-R6X0
	End cap	TLS-R600
	Turned connector	TLS-R860
	Straight connector	TLS-R861
	Power feeder of track	TLS-R862(N)
	I-shaped electrical connector	TLS-R863(N)
	Female end cap	TLS-R865
	Ceiling screw	CL-21
	Track pendant rod	PG-I
	Track pendant cable	PN-D

Picture	Name	Model
	Ceiling accessories	CL-18
	Pendant accessories	TLS-R892
	Neon lights Pendant rod (1-2 Meter Adjustable)	TLS-R893
	Neon lights Pendant rod (0.5-1 Meter Adjustable)	TLS-R895
	48V Constant Voltage Power supply	BN-V48-XXXP















Note:

- 1, Please refer to the accessory list table for detailed parameters.
- 2, Different tracks need to be used with corresponding accessories

◎Packing

Model	Size (mm/box)	Quantity /box	Quantity /carton	NW (kg/box)	NW (kg/carton)	GW (kg)	Size (mm/carton)
TLS-MT20CDO600-12904OFF-NBW	610*81*37 [24"*3.19"*1.46"]	1	20	0.2	4	8	620*338*200 [24.41"*13.31"*7.87"]
TLS-MT20CDO900-18904OFF-NBW	1210*81*37 [47.64"*3.19"*1.46"]	1	10	0.3	3	5.3	1230*195*172 [48.43"*7.68"*6.77"]
TLS-MT20CD1200-24904OFF-NBW	1210*81*37 [47.64"*3.19"*1.46"]	1	10	0.4	4	6.5	1230*195*172 [48.43"*7.68"*6.77"]

◎Model Code

TLS	-	M	T	20	C	D	0600	(T)	-	12	90	40	FF	-	N	B	W
																	

◎Attentions

- 1、 Non-professionals are prohibited from installing, disassembling and repairing the product.
- 2、 Avoid scratching, distortion and irregular bending of the product during installation; otherwise it may cause irreparable damage to the product.
- 3、 Please use professional cutting tools when cutting
- 4、 Do not use any acid or alkaline adhesive to fix products
- 5、 The product is only suitable for indoor dry places, can not be used in outdoor, seaside or wet environment.
- 6、 PC features: Each 10°C rise or drop will make diffuser extend or shrink 0.8mm/m, please confirm before processing and use